

DIMENSION SCAN 68-2, 68-7 AND 68-8 (WALL HUNG MODEL)

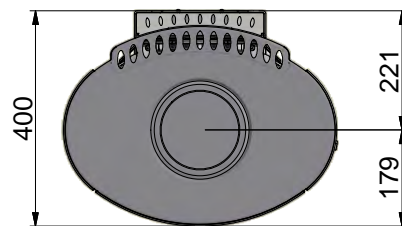
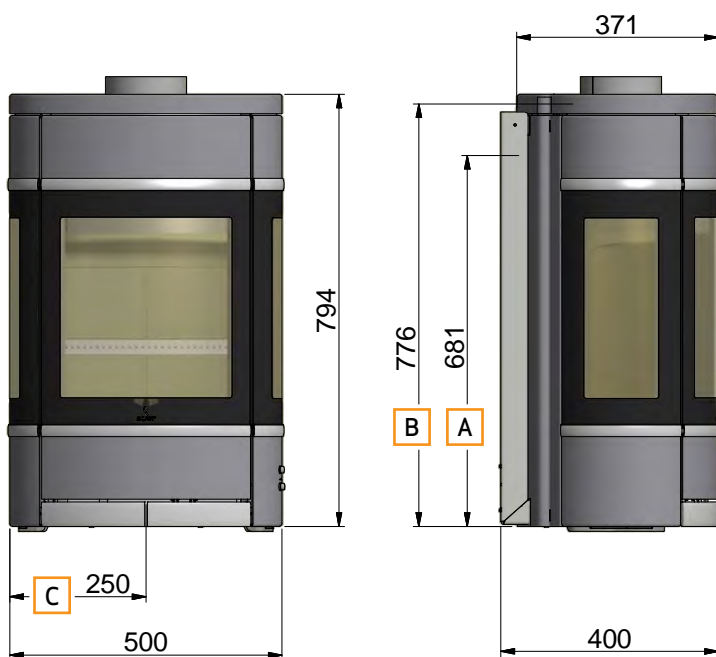

- A** Centre rear outlet
- B** Height to the beginning of the connecting piece at top outlet
- C** Centre of fresh air intake

All measurements are in millimeters

DIMENSION SKETCH SCAN 68-3, 68-4, 68-9 AND 68-10 (PEDESTAL)

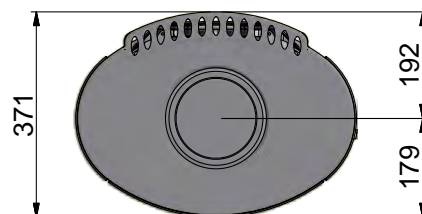
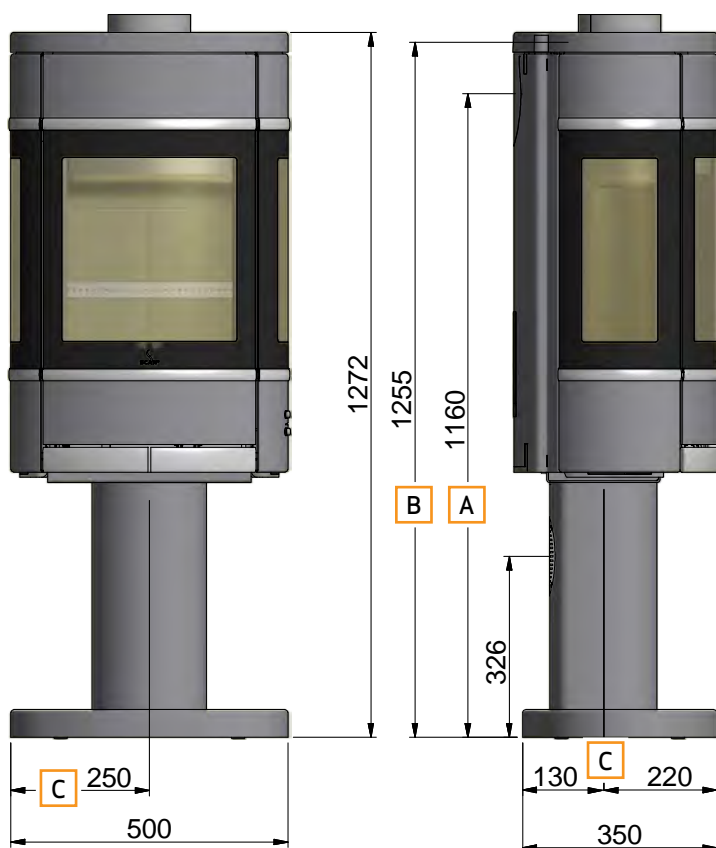

- A** Centre rear outlet
- B** Height to the beginning of the connecting piece at top outlet
- C** Centre of fresh air intake

All measurements are in millimeters

DIMENSION SKETCH SCAN 68-11 AND 68-12 (PORTAL)

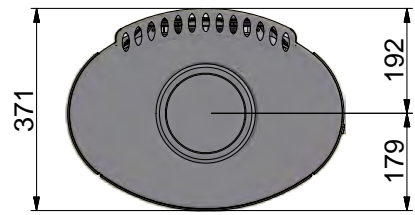
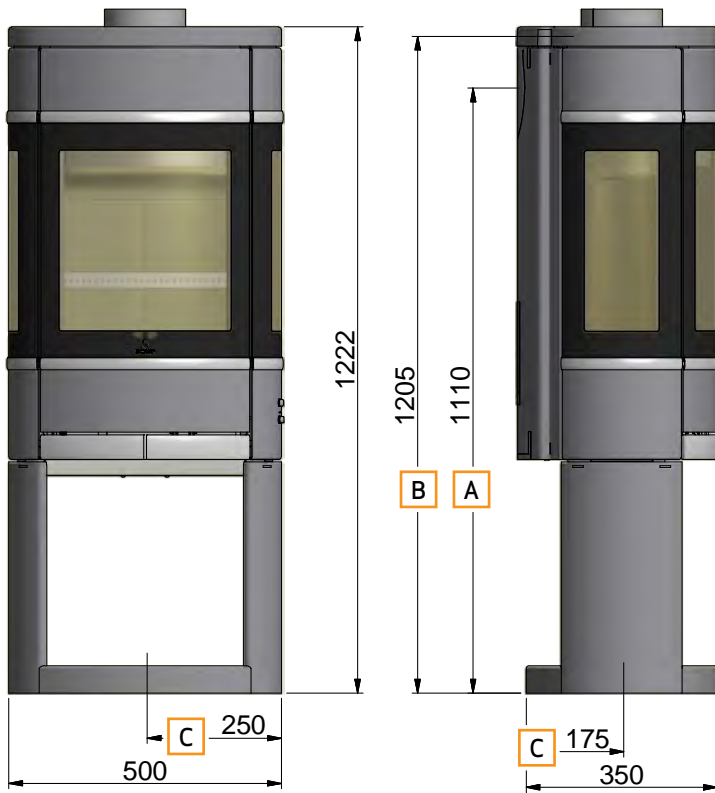

- A** Centre rear outlet
- B** Height to the beginning of the connecting piece at top outlet
- C** Centre of fresh air intake

All measurements are in millimeters

DIMENSION SKETCH SCAN 68-13 LB (LOW BASE)

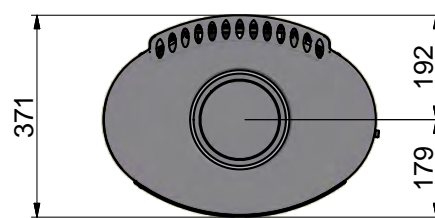
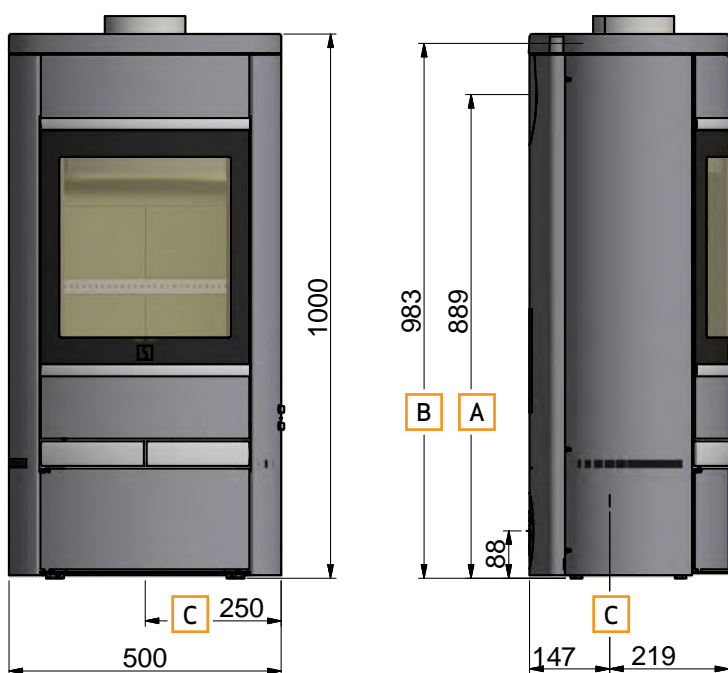

- A** Centre rear outlet
- B** Height to the beginning of the connecting piece at top outlet
- C** Centre of fresh air intake

All measurements are in millimeters

DIMENSION SKETCH 68-13 AND 68-14 (STEEL SIDES)

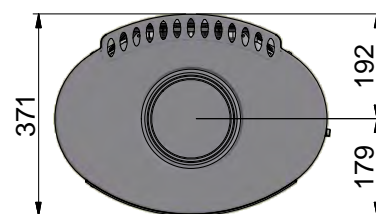

- A** Centre rear outlet
- B** Height to the beginning of the connecting piece at top outlet
- C** Centre of fresh air intake

All measurements are in millimeters

DIMENSION SKETCH SCAN 68-13 AND 68-14 HT (HIGH TOP)

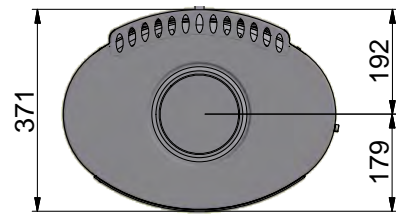
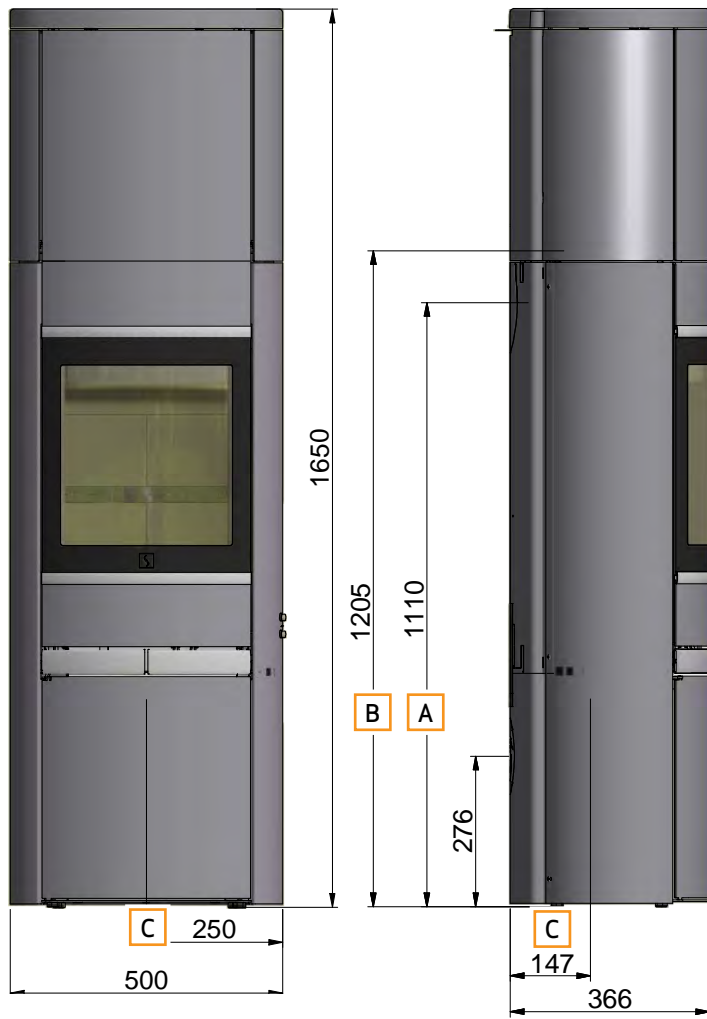

- A** Centre rear outlet
- B** Height to the beginning of the connecting piece at top outlet
- C** Centre of fresh air intake

All measurements are in millimeters

DIMENSION SKETCH SCAN 68-15 LB (SOAPSTONE + LOW BASE)

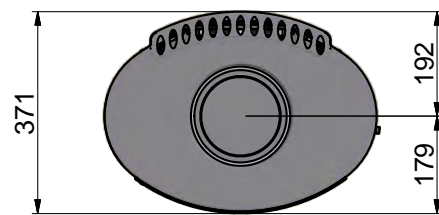
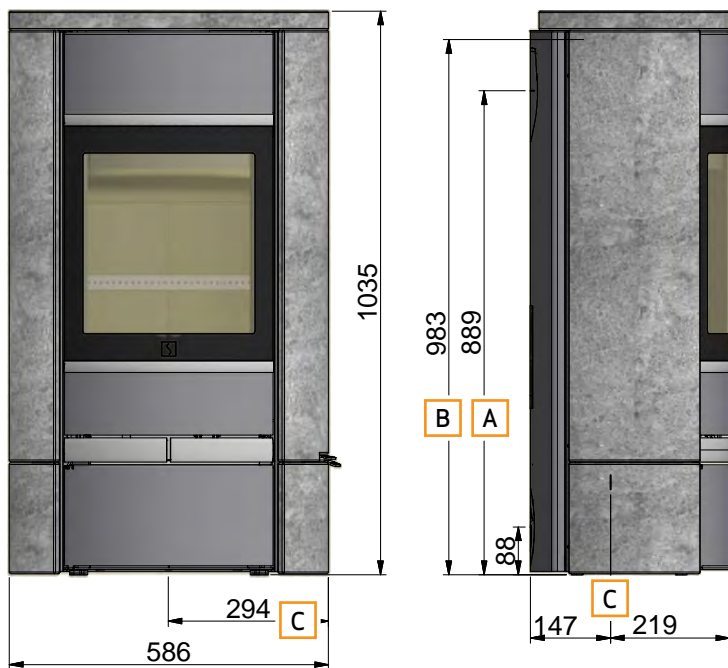

- A** Centre rear outlet
- B** Height to the beginning of the connecting piece at top outlet
- C** Centre of fresh air intake

All measurements are in millimeters

DIMENSION SKETCH SCAN 68-15 (SOAPSTONE)

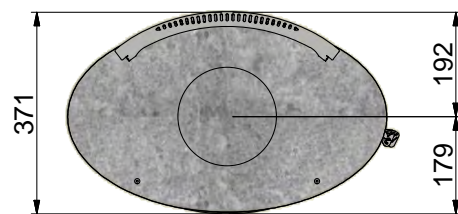

- A** Centre rear outlet
- B** Height to the beginning of the connecting piece at top outlet
- C** Centre of fresh air intake

All measurements are in millimeters